

4

3

2

1

A

A

B

B

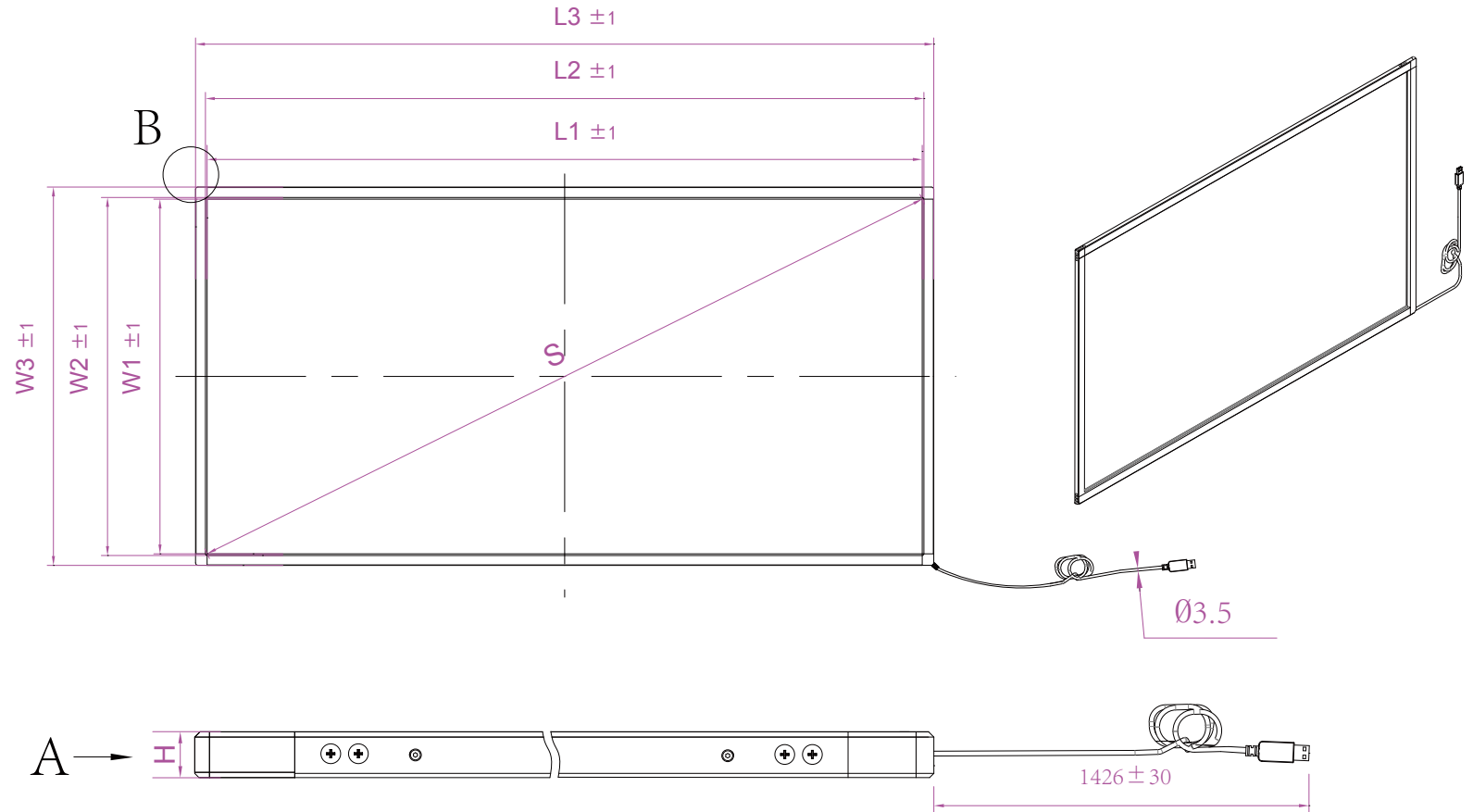
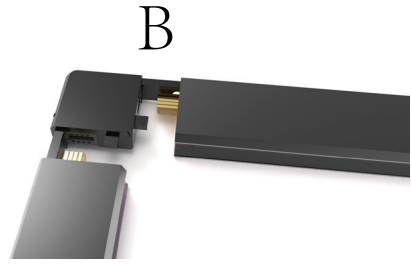

C

C

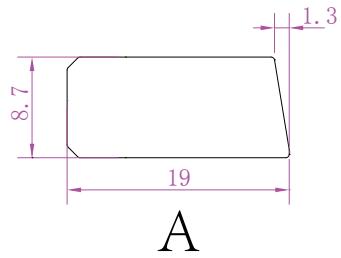

D

D

S(Inch/mm)	30.15"/766.02
W1	378.1 ± 1
W2	380.7 ± 1
W3	416.1 ± 1
L1	667.2 ± 1
L2	669.8 ± 1
L3	705.2 ± 1
H	8.7 ± 0.2



Anti-Sunlight, No Blind Zone For Any Size



X Slim Series							
Material:	aluminum	Unit:	mm	Date:		Rev:	1.0
Draft by:				Approved by:			

4

3

2

1