

4

3

2

1

A

B

C

D

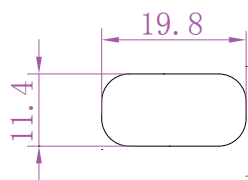
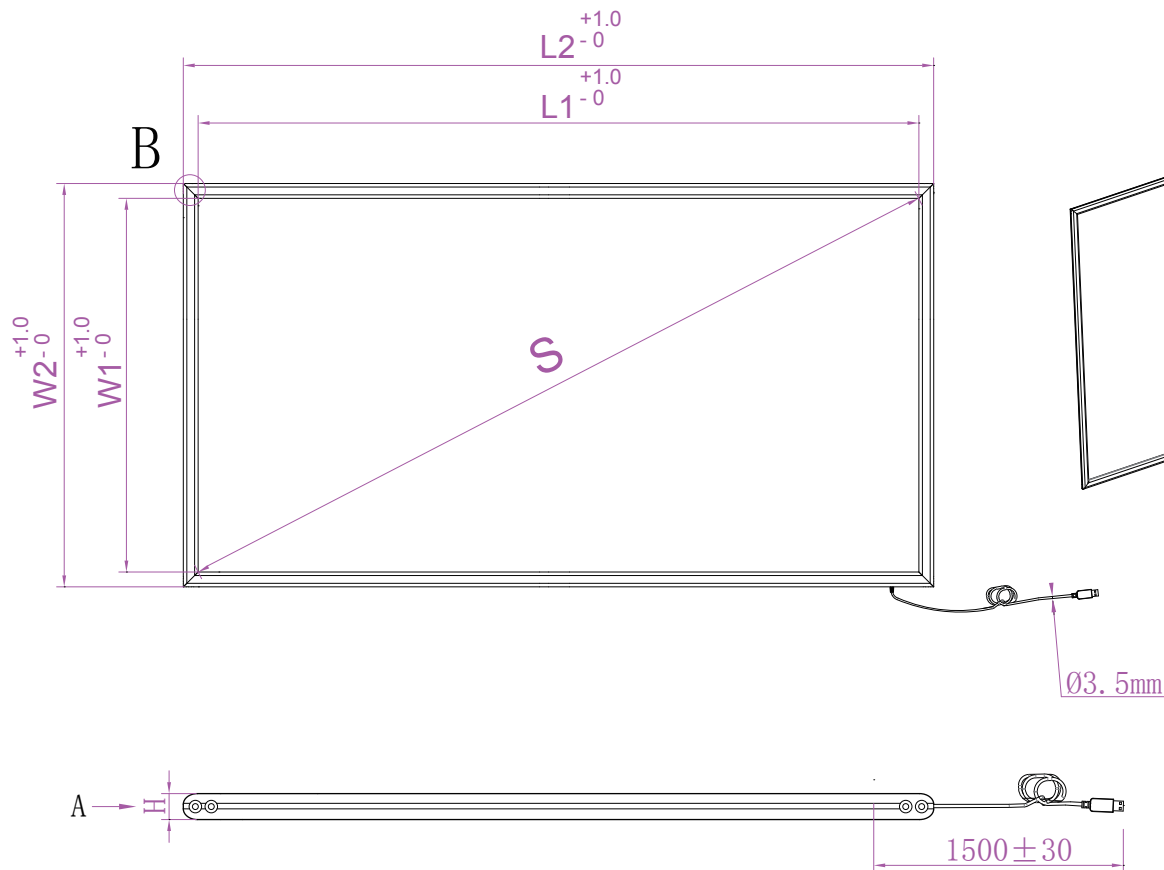
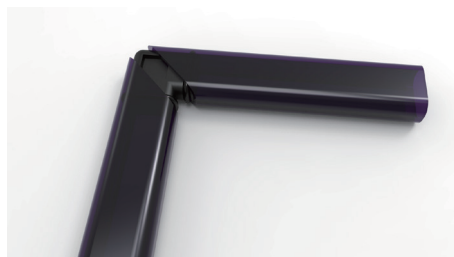

A

S(Inch/mm)	70.66"/1794.70
W1	883.1(+1/-0)
W2	922.7(+1/-0)
L1	1561.6(+1/-0)
L2	1601.2(+1/-0)
H	11.4 ±0.2



Anti-Sunlight, No Blind Zone For Any Size



Material:	plastic	Unit:	mm	Date:		Rev:	1.0
Draft by:				Approved by:			

4

3

2

1