

4

3

2

1

A

B

C

D

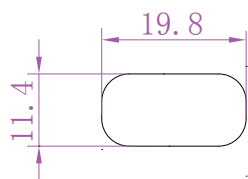
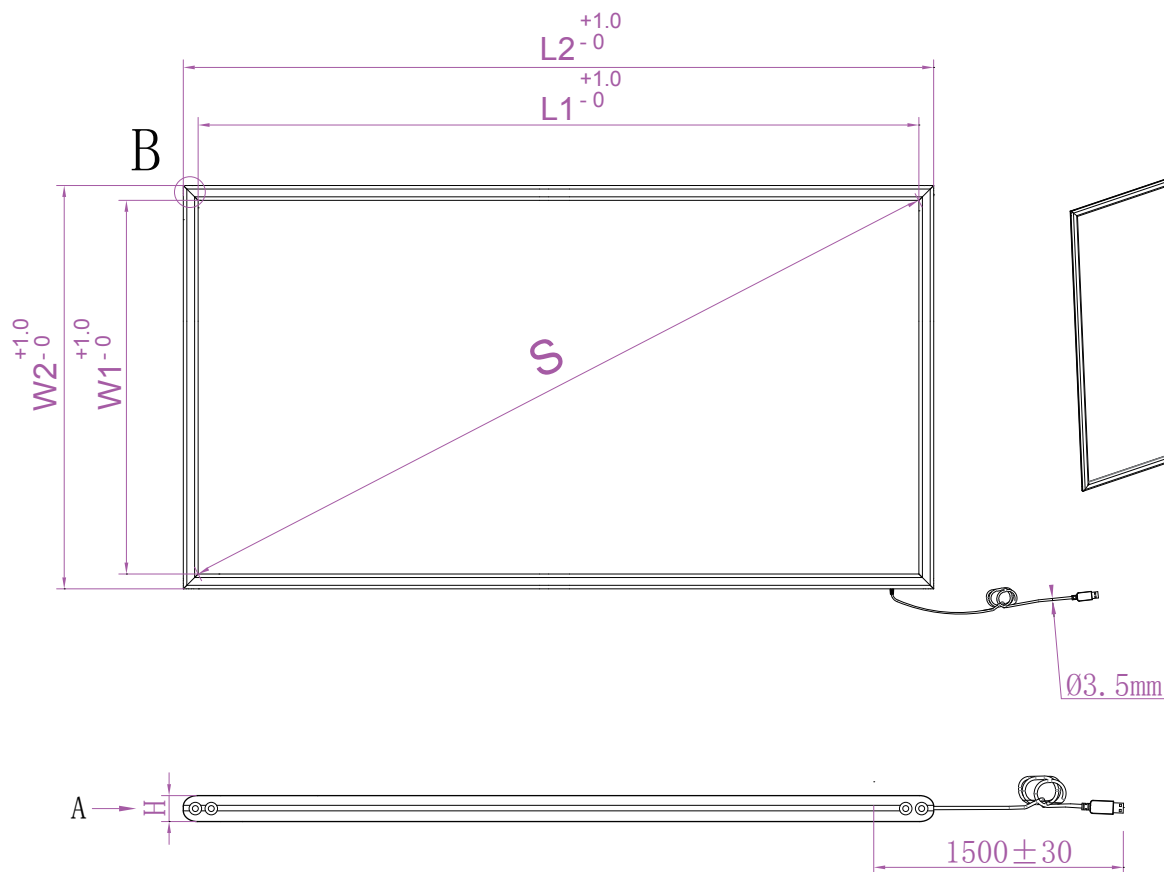

A

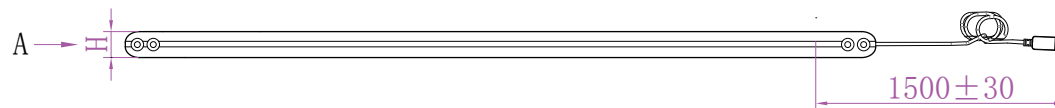

S(Inch/mm)	49.10"/1247.33
W1	617.6(+1/-0)
W2	657.2(+1/-0)
L1	1083.7 (+1/-0)
L2	1123.3(+1/-0)
H	11.4 ±0.2



Anti-Sunlight, No Blind Zone For Any Size



Material:	plastic	Unit:	mm	Date:		Rev:	1.0
Draft by:		Approved by:					

4

3

2

1